



# L100EL & L150EL

Losone Select Inline/Cabinet Ventilators

Incredibly reliable. Unbelievably quiet.  
Offering the CFM choices you need at the lowest sound levels in the industry.

## FEATURES:

### Blower:

- Low RPM for quiet operation
- Resilient anti-vibration mounts
- Dynamically-balanced, polymeric, centrifugal blower wheel for quiet, efficient performance
- Permanently lubricated, thermally protected motor
- Plug-in motor rated at 120 VAC
- Designed for continuous operation

### Housing:

- Rugged, 20 gauge galvanized steel
- 6" round duct connectors
- May be installed in ceiling or wall (size permitting)
- 8-position mounting brackets for easy installation and greater adaptability to various mounting requirements
- Automatic backdraft damper located within duct connector
- Factory-shipped in horizontal discharge position - easily converted to vertical discharge
- Removable panel allows easy access to the motor without disturbing ductwork
- Suitable for kitchen installations

## TYPICAL SPECIFICATION:

Ventilator shall have galvanized steel housing insulated with at least 1/2" of acoustic insulation. Housing to have adjustable mounting brackets and removable panel to allow motor access without disturbing ductwork.

Automatic backdraft damper to be located within duct connector.

Blower unit shall be removable from housing and shall have a dynamically balanced centrifugal-type blower wheel. Motor to be permanently lubricated and mounted with resilient antivibration mounts.

Air delivery shall be no less and sound levels no greater than listed for each model. All air and sound ratings shall be certified by AMCA and HVI. Units to be cULus Listed.



S&P USA Ventilation Systems, LLC, Div. of Soler & Palau Ventilation Group, certifies that the Losone Select Series shown herein are licensed to bear the AMCA Seal. The ratings shown are based on test and procedures performed in accordance with AMCA Publication 211 and AMCA Publication 311 and comply with the requirement of the AMCA Certified Ratings Program.

## WEIGHT:



MODEL NO.	SHIPPING WEIGHT
L100EL	23.0 lbs.
L150EL	23.1 lbs.

## DIMENSIONS:

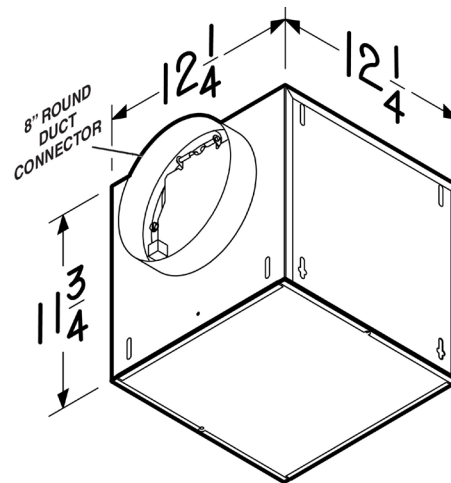



# L100EL & L150EL

Losone Select Inline/Cabinet Ventilators



## PERFORMANCE RATINGS:

### AMCA LICENSED PERFORMANCE RATINGS

MODEL NO.	NOMINAL VOLTAGE	CFM/SONES - AT STATIC PRESSURES (Ps - inches of H <sub>2</sub> O)											NOMINAL RPM	AMPS @ 60 Hz	WATTS
			0.0" Ps	.10" Ps	.125" Ps	.250" Ps	.375" Ps	.50" Ps	.625" Ps	.750" Ps	.875" Ps	1.0" Ps			
L100L	120 VAC	CFM St. Thr.	148	127	122	95	64	27	0	-	-	-	918	0.3	120
L150L	120 VAC	CFM St. Thr.	210	191	186	164	135	99	57	0	-	-	1104	0.4	120

Performance ratings include the effects of backdraft damper in the airstream. Speed (RPM) shown is nominal. Performance is based on actual speed of test. The sound ratings shown are loudness values in fan sones at 5' (1.5m) in a hemispherical free field calculated per AMCA Std. 301. Values shown are for Installation Type D: Ducted inlet, Ducted outlet. Ratings do not include the effect of duct end correction. Performance ratings include the effects of 18 feet of round inlet duct and, if needed, a rectangular to round duct transition in the airstream. Performance shown is for Installation Type D: Ducted inlet, Ducted outlet.

## HVI PERFORMANCE

MODEL NO.	Ducting	0.2" Ps	
		CFM	CFM/Watt
L100EL	Horizontal	106	4.2
L150EL	Horizontal	174	4.2

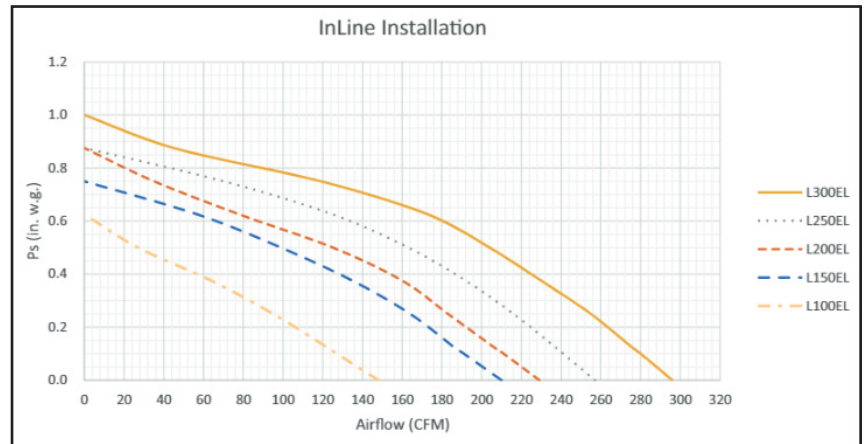

HVI-2100 CERTIFIED RATINGS comply with new testing technologies and procedures prescribed by the Home Ventilating Institute, for off-the-shelf products, as they are available to consumers. Product performance is rated at 0.1in. static pressure, based on tests conducted in a state-of-the-art test laboratory. Sones are a measure of humanly-perceived loudness, based on laboratory measurements.



S&P USA Ventilation Systems, LLC., Div. of Soler & Palau Ventilation Group, certifies that the Losone Select Series shown herein are licensed to bear the AMCA Seal. The ratings shown are based on test and procedures performed in accordance with AMCA Publication 211 and AMCA Publication 311 and comply with the requirement of the AMCA Certified Ratings Program.



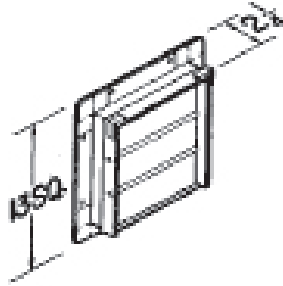

### Model 441 Wall Cap

- Gravity dampers
- Collar with birdscreen for attaching 10" round duct
- Steel construction with aluminum louvers

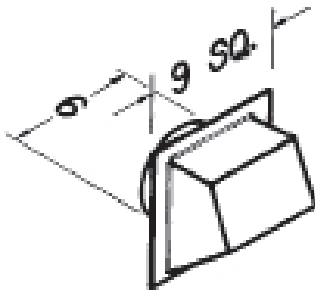

### Model 641 Wall Cap

- Aluminum natural finish
- Built-in backdraft damper & birdscreen
- For 6" round duct

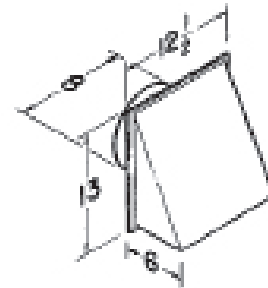

### Model 643 Wall Cap

- Aluminum natural finish
- Built-in backdraft damper
- For 8" round duct

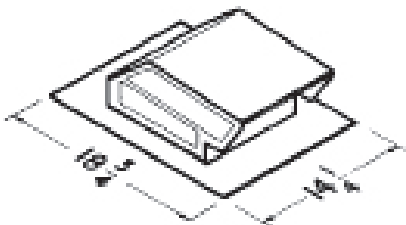

### Model 634 Roof Cap

- Black electrically - bonded epoxy finish
- Built-in backdraft damper & birdscreen
- For 3 1/4" x 10" or up to 8" round duct

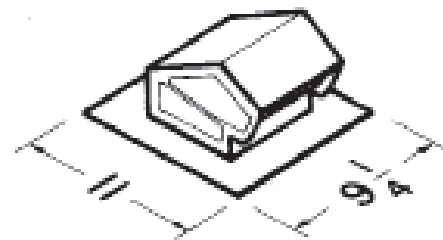

### Model 636 Roof Cap

- Black electrically - bonded epoxy finish
- Built-in backdraft damper & birdscreen
- For 3" or 4" round duct



### Speed Control

- Adjust speed from 100 to 50%
- 5 amp & 10 amp - 120V

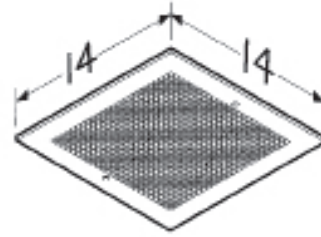

### Model MG 1 Metal Grille Kit

- White enamel painted steel
- Mounting screws included
- Fits L100E, L150E, L200E, L250E & L300E

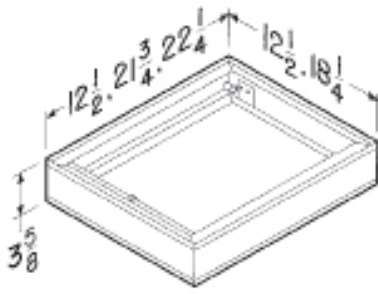

### Models RD1, RD2 & RD3 Radiation Dampers

- UL rated for use in 1, 2 or 3 hour rated floor-ceiling, roof-ceiling design
- Galvanized steel frame
- High temperature, non-asbestos, reinforced fiberthermal fabric
- 212 °F fusible link
- Stainless steel negator-type closure spring
- RD1 (12 1/2" X 12 1/2") fits L100E - L300E
- RD2 (21 3/4" X 12 1/2") fits L400 - L700
- RD3 (22.25" X 18.25") fits L900 - L1500

OPTIONAL ACCESSORY COMPATIBILITY CHART		LOSONE SELECT CEILING MOUNT						LOSONE SELECT IN-LINE/CABINET					
		L100E L150E	L200E L250E L300E	L400 L500	L700	L900	L1500	L100EL L150EL	L200EL L250EL L300EL	L400L L500L L700L	L900L	L1500L	L2000L
VARIABLE SPEED CONTROLS	2727.1 (5 AMP 120V) ●	X	X	X			X	X					
	2828.1 (10AMP 120V) ●	X	X	X	X	X	X	X	X	X	X	X	X
Roof Caps	634 ●	X	X					X	X				
	636 ●												
WALL CAPS	441 ◆			X	X					X			
	641 ●	X						X					
	643 ●		X						X				
UL RADIATION DAMPERS	RD1 ◆	X	X										
	RD2 ◆			X	X								
	RD3 ◆					X	X						
METAL GRILLE KIT	MG1 ●	X	X										
VIBRATION DAMPENING HANGERS (4)	V102 ●	X	X	X	X	X		X	X	X	X		
	V104KIT ●	X	X	X	X	X	X	X	X	X	X	X	X



# L200EL, L250EL & L300EL

Losone Select Inline/Cabinet Ventilators

Incredibly reliable. Unbelievably quiet.  
Offering the CFM choices you need at the lowest sound levels in the industry.

## FEATURES:

### Blower:

- Low RPM for quiet operation
- Resilient anti-vibration mounts
- Dynamically-balanced, polymeric, centrifugal blower wheel for quiet, efficient performance
- Permanently lubricated, thermally protected motor
- Plug-in motor rated at 120 VAC
- Designed for continuous operation

### Housing:

- Rugged, galvanized steel
- 8" round duct connectors
- May be installed in ceiling or wall (size permitting)
- 8-position mounting brackets for easy installation and greater adaptability to various mounting requirements
- Automatic backdraft damper located within duct connector
- Factory-shipped in horizontal discharge position - easily converted to vertical discharge
- Removable panel allows easy access to the motor without disturbing ductwork
- Suitable for kitchen installations

## TYPICAL SPECIFICATION:

Ventilator shall have galvanized steel housing. Housing to have adjustable mounting brackets and removable panel to allow access to motor without disturbing ductwork.

Automatic backdraft damper to be located within duct connector. Duct connector, blower assembly and wiring plate shall be adjustable for either horizontal or vertical installation.

Blower unit shall be removable from housing and will have a polymeric, dynamically balanced centrifugal-type blower wheel. Motor to be permanently lubricated and mounted with resilient anti-vibration mounts. RPM not to exceed number listed for each model.

Air delivery shall be no less and sound levels no greater than listed for each model. All air and sound ratings shall be certified by AMCA. Units to be cULus listed.

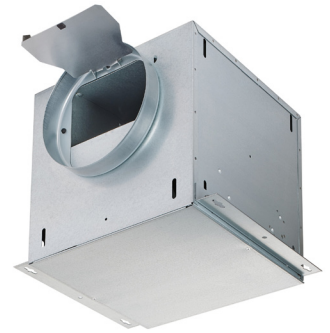

S&P USA Ventilation Systems, LLC, Div. of Soler & Palau Ventilation Group, certifies that the Losone Select Series shown herein are licensed to bear the AMCA Seal. The ratings shown are based on test and procedures performed in accordance with AMCA Publication 211 and AMCA Publication 311 and comply with the requirement of the AMCA Certified Ratings Program.



## WEIGHT:

MODEL NO.	SHIPPING WEIGHT
L200EL	23.9 lbs.
L250EL	24.0 lbs.
L300EL	25.2 lbs.

## DIMENSIONS:

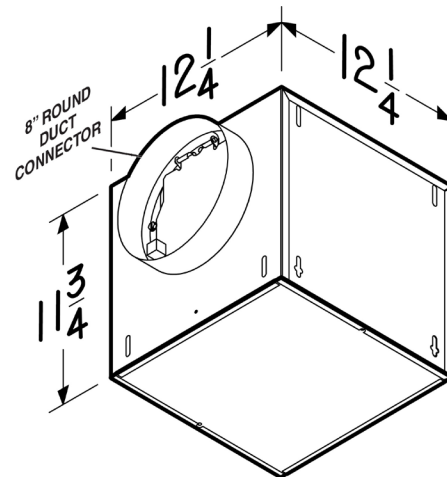



# L200EL, L250EL & L300EL

Losone Select Inline/Cabinet Ventilators

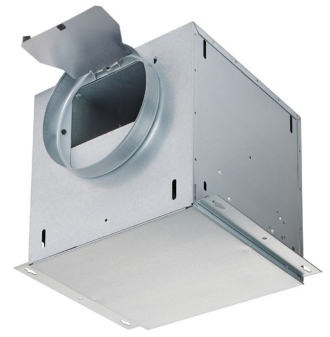

## PERFORMANCE RATINGS:

### AMCA LICENSED PERFORMANCE RATINGS

MODEL NO.	NOMINAL VOLTAGE	CFM/SONES - AT STATIC PRESSURES (Ps - inches of H <sub>2</sub> O)											NOMINAL RPM	AMPS @ 60 Hz	WATTS
			0.0" Ps	.10" Ps	.125" Ps	.250" Ps	.375" Ps	.50" Ps	.625" Ps	.750" Ps	.875" Ps	1.0" Ps			
L200EL	120 VAC	CFM St. Thr.	229	211	206	183	160	125	78	35	0	-	1150	0.5	127
L250EL	120 VAC	CFM St. Thr.	257	241	237	216	192	163	125	70	0	-	1228	0.6	166
L300EL	120 VAC	CFM St. Thr.	296	280	275.5	255	230	204	173	119	45	0	1129	0.7	212

Performance ratings include the effects of backdraft damper in the airstream. Speed (RPM) shown is nominal. Performance is based on actual speed of test. The sound ratings shown are loudness values in fan sones at 5' (1.5m) in a hemispherical free field calculated per AMCA Std. 301. Values shown are for Installation Type D: Ducted inlet, Ducted outlet. Ratings do not include the effect of duct end correction. Performance ratings include the effects of 18 feet of round inlet duct and, if needed, a rectangular to round duct transition in the airstream. Performance shown is for Installation Type D: Ducted inlet, Ducted outlet.

## HVI PERFORMANCE

MODEL NO.	Ducting	0.2" Ps	
		CFM	CFM/Watt
L200EL	Horizontal	200	4.0
L250EL	Horizontal	233	3.9
L300EL	Horizontal	270	3.8

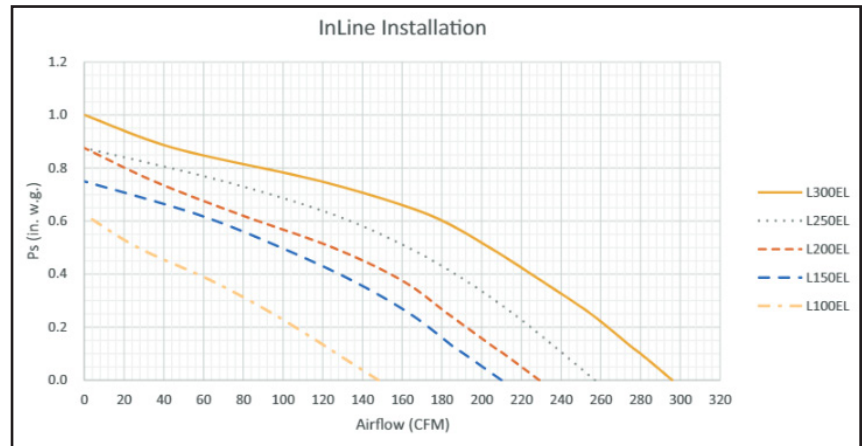

HVI-2100 CERTIFIED RATINGS comply with new testing technologies and procedures prescribed by the Home Ventilating Institute, for off-the-shelf products, as they are available to consumers. Product performance is rated at 0.1 in. static pressure, based on tests conducted in a state-of-the-art test laboratory. Sones are a measure of humanly-perceived loudness, based on laboratory measurements.



S&P USA Ventilation Systems, LLC., Div. of Soler & Palau Ventilation Group, certifies that the Losone Select Series shown herein are licensed to bear the AMCA Seal. The ratings shown are based on test and procedures performed in accordance with AMCA Publication 211 and AMCA Publication 311 and comply with the requirement of the AMCA Certified Ratings Program.



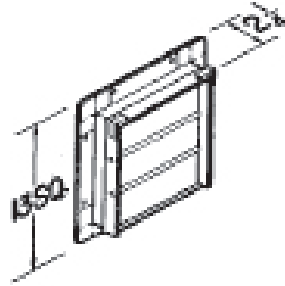

### Model 441 Wall Cap

- Gravity dampers
- Collar with birdscreen for attaching 10" round duct
- Steel construction with aluminum louvers

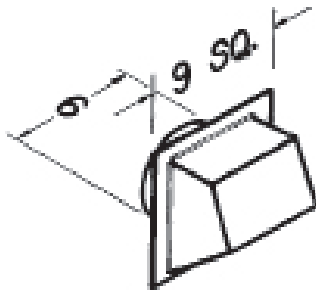

### Model 641 Wall Cap

- Aluminum natural finish
- Built-in backdraft damper & birdscreen
- For 6" round duct

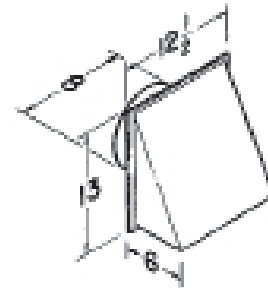

### Model 643 Wall Cap

- Aluminum natural finish
- Built-in backdraft damper
- For 8" round duct

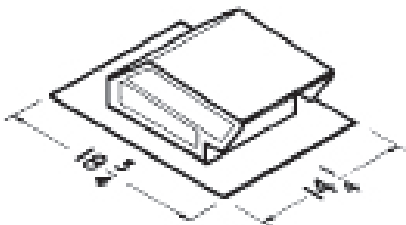

### Model 634 Roof Cap

- Black electrically - bonded epoxy finish
- Built-in backdraft damper & birdscreen
- For 3 1/4" x 10" or up to 8" round duct

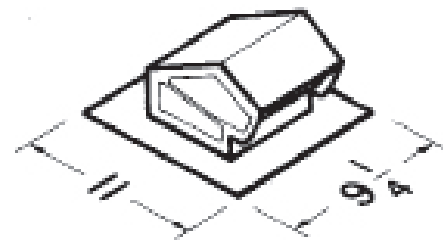

### Model 636 Roof Cap

- Black electrically - bonded epoxy finish
- Built-in backdraft damper & birdscreen
- For 3" or 4" round duct

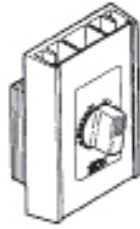

### Speed Control

- Adjust speed from 100 to 50%
- 5 amp & 10 amp - 120V

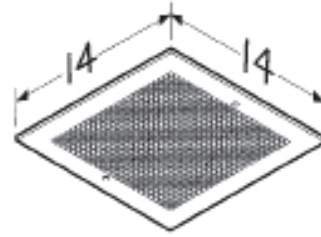

### Model MG 1 Metal Grille Kit

- White enamel painted steel
- Mounting screws included
- Fits L100E, L150E, L200E, L250E & L300E

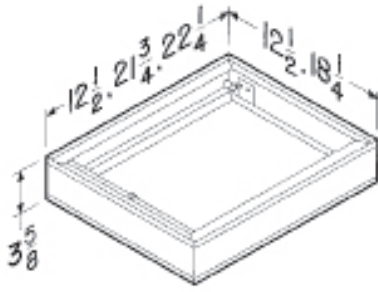

### Models RD1, RD2 & RD3 Radiation Dampers

- UL rated for use in 1, 2 or 3 hour rated floor-ceiling, roof-ceiling design
- Galvanized steel frame
- High temperature, non-asbestos, reinforced fiberthermal fabric
- 212 °F fusible link
- Stainless steel negator-type closure spring
- RD1 (12 1/2" X 12 1/2") fits L100E - L300E
- RD2 (21 3/4" X 12 1/2") fits L400 - L700
- RD3 (22.25" X 18.25") fits L900 - L1500

OPTIONAL ACCESSORY COMPATIBILITY CHART		LOSONE SELECT CEILING MOUNT						LOSONE SELECT IN-LINE/CABINET					
		L100E L150E	L200E L250E L300E	L400 L500	L700	L900	L1500	L100EL L150EL	L200EL L250EL L300EL	L400L L500L L700L	L900L	L1500L	L2000L
VARIABLE SPEED CONTROLS	2727.1 (5 AMP 120V) ●	X	X	X			X	X					
	2828.1 (10AMP 120V) ●	X	X	X	X	X	X	X	X	X	X	X	X
Roof Caps	634 ●	X	X					X	X				
	636 ●												
WALL CAPS	441 ◆			X	X					X			
	641 ●	X						X					
	643 ●		X						X				
UL RADIATION DAMPERS	RD1 ◆	X	X										
	RD2 ◆			X	X								
	RD3 ◆					X	X						
METAL GRILLE KIT	MG1 ●	X	X										
VIBRATION DAMPENING HANGERS (4)	V102 ●	X	X	X	X	X		X	X	X	X		
	V104KIT ●	X	X	X	X	X	X	X	X	X	X	X	X