



TD MIXVENT

In-line Mixed Flow Duct Fan



For high air flow to pressure ratio applications.
Ideal for applications where space is limited.

FEATURES:

- Exhaust air up to 2,630 CFM with static pressure capabilities to 1" w.g.
- Mixed flow impeller for excellent airflow to pressure performance ratio
- Ideal for applications where space is limited
- AMCA Seal for Air Performance
- cULus Listed
- ENERGY STAR® qualified



*Excluding the TD-355 & TD-400

TYPICAL SPECIFICATION:

The TD-MIXVENT series are in-line duct fans specially designed to maximize the airflow performance with minimal noise levels in a small, compact housing. This makes the TD-MIXVENT series the ultimate solution for small to medium sized ventilation installations which require a high airflow to pressure ratio and occupy minimum space.

All models include a "removable body" feature that enables the motor-impeller assembly to be completely removed or replaced without the need to interfere with the attached ducting. These models incorporate a powerful mixed flow impeller and internal air vanes located at the discharge end of the fan housing. This impeller and guide vane combination provides a smooth laminar airflow which in turn minimizes turbulence and noise and generates excellent airflow to static pressure performance ratio.

The unique design of the support brackets allows the motor and impeller assembly to be fitted or removed without dismantling the adjacent ducting, therefore facilitating any installation or maintenance. The internal aerodynamic design of the fan enables the unit to generate large air volumes and pressures with the minimum of in-duct or radiated noise. These fans offer an ideal in-line duct fan solution for a wide range of HVAC ventilation applications.

DIMENSIONS inches/mm:

Model	X	A	B	C	D	E	F	G	H
TD-100	5 15/16 151	9 1/8 232	5 7/16 138	3 3/4 96	3 7/8 98	3 1/4 82	3 3/4 95	1 7/8 48	2 1/16 52
TD-100x1	7 3/8 188	11 15/16 303	6 15/16 176	4 1/2 115	3 13/16 97	3 15/16 100	3 9/16 90	3 1/8 80	2 3/8 60
TD-125	7 3/8 188	10 3/16 258	6 15/16 176	4 1/2 115	4 13/16 123	3 15/16 100	3 9/16 90	3 1/8 80	2 3/8 60
TD-150	8 3/8 212	11 5/8 295	7 7/8 200	5 127	5 13/16 147	4 7/16 112	5 1/8 130	3 1/8 80	2 3/8 60
TD-200	9 3/16 233	11 7/8 302	8 9/16 217	5 9/16 141	7 13/16 198	4 7/8 124	5 1/2 140	3 15/16 100	3 11/16 94
TD-250	11 7/16 291	15 3/16 386	10 11/16 272	7 9/16 192	9 3/4 248	6 1/8 155	6 5/8 168	5 11/16 145	5 1/2 140
TD-315	14 356	17 11/16 450	13 1/4 336	8 13/16 224	12 5/16 312	7 3/8 188	8 1/4 210	7 3/16 182	7 178

Models 100-315

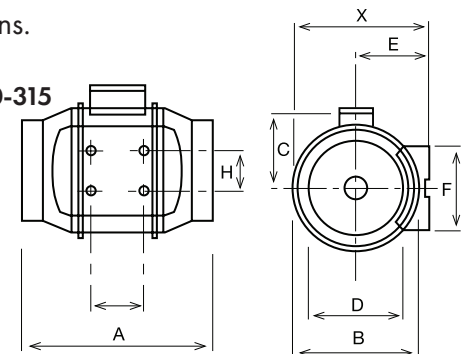

Models 355-400

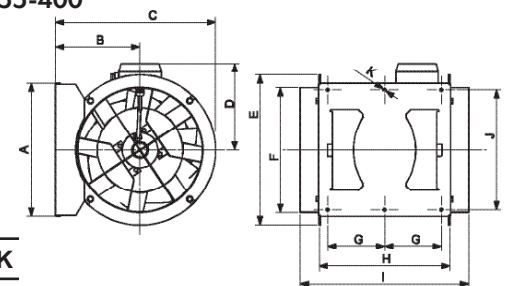

Model	A	B	C	D	E	F	G	H	I	J	K
TD-355	14 13/16 376	9 3/8 238	17 3/4 451	8 13/16 224	16 3/4 425	13 15/16 354	6 5/16 160	14 1/2 368	18 11/16 475	13 3/8 340	5/16 8
TD-400	16 407	9 13/16 249	19 3/8 492	10 1/2 267	19 3/16 487	15 11/16 398	6 5/16 160	16 3/4 425	21 1/2 546	14 9/16 370	5/16 8

All specifications are subject to change without notice unless approved in submittal by S&P.
TD MIXVENT_Submittal_06172022



TD MIXVENT

In-line Mixed Flow Duct Fan



PERFORMANCE CHARACTERISTICS:

The TD-250 and TD-315 have two speed motor connections.
All other fan models have a single speed motor connection.

AMCA CERTIFIED PERFORMANCE

Model	Nom. RPM	Volts / Frequency	Max. Watts @ 0.2" w.g.	Max. CFM	Max. Current (Amps)	Max. SP	Max. Operating Temp. (°F)	Duct Dia. Inches
TD-100	2516	120V / 60Hz	26	101	0.45	0.4"	104°F	4"
TD-100X1	2500	120V / 60Hz	33	135	0.24	0.45"	104°F	4"
TD-125	2146	120V / 60Hz	38	197	0.72	0.55"	104°F	5"
TD-150	2289	120V / 60Hz	65	293	0.54	1.15"	140°F	6"
TD-200	2781	120V / 60Hz	184	538	0.8	1.625"	104 F	8"
TD-250 LS	2400	115V / 60Hz	162	541	2.2A	2.03"	140°F	10"
TD-250 HS	3200	115V / 60Hz	241	754	2.2A	2.53"	140°F	10"
TD-315 LS	2000	115V / 60Hz	208	751	2.3A	1.62"	140°F	12.4"
TD-315 HS	2500	115V / 60Hz	335	1050	2.3A	2.95"	140°F	12.4"
TD-355	1536	115V / 60Hz	522	2089	3.9A	1.0"	140°F	14"
TD-400	1559	115V / 60Hz	916	3127	6.3A	1.2"	140°F	16"



S&P USA Ventilation Systems, LLC. certifies that all TD fan sizes shown herein are licensed to bear the AMCA Seal. The ratings shown are based on tests and procedures performed in accordance with AMCA Publication 211 and comply with the requirements of the AMCA Certified Ratings Program.

Performance certified is for installation Type D: Ducted Inlet, Ducted Outlet. Performance ratings do not include the effects of appurtenances.
LS = Low Speed / HS = High Speed
AMCA Licensed performance ratings.

HVI CERTIFIED PERFORMANCE

Model	Nom. RPM	Volts	Max. Watts @ 0.2" w.g.	CFM v Static Pressure (SP) Ins. WG												Max. Current (Amps)	Duct Dia. Ins.
				0	0.125	0.2	0.25	0.3	0.375	0.4	0.5	0.75	1	1.25	1.5		
TD-100	2564	120	23.5	101	84	70	57	34	18	15	1	-	-	-	-	0.45	4"
TD-100x1	2352	120	26.4	131	112	100	90	78	57	44	27	-	-	-	-	0.23	4"
TD-125	2392	120	37.8	200	177	160	146	129	89	78	41	-	-	-	-	0.32	5"
TD-150	2290	120	62.1	295	272	260	251	242	229	224	204	122	33	-	-	0.54	6"
TD-200	2022	120	113	475	448	430	418	406	385	378	352	264	142	-	-	1.03	8"
TD-250 HS	2721	120	210	815	782	760	744	726	699	690	654	561	449	322	241	2.27	10"
TD-250 LS	1982	120	147	612	557	520	493	463	417	401	329	233	178	135	75	1.32	10"
TD-315 HS	2559	120	303	1027	965	940	925	908	875	862	803	672	505	368	291	2.49	12"
TD-315 LS	1888	120	194	811	726	660	633	592	532	512	421	234	168	110	51	1.55	12"



LS = Low Speed / HS = High Speed
HVI certified performance is at 0.2" of static pressure